

**USER MANUAL
FOR
10.1 " PANEL PC**

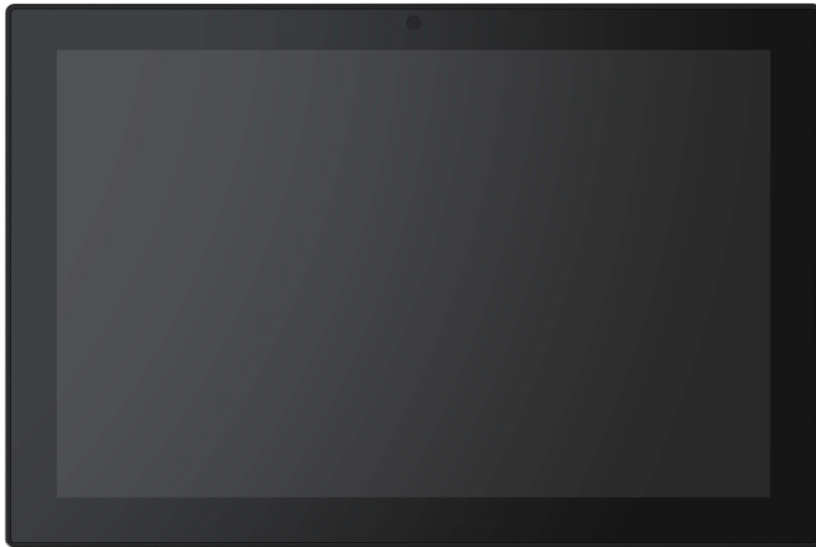

Important Safety Instructions

Read these safety instructions carefully:

- Keep this equipment away from humidity and extreme temperature.
- Avoid exposing the device to direct sunlight or strong ultraviolet light for a long time.
- Do not drop the device or expose it to strong vibrations.
- Do not scratch or rub the screen with a hard or sharp object.
- Please turn off the power and unplug the power cable before cleaning the device, then wipe it with a moist and soft cloth.
- Do not disassemble or repair the device by yourselves without our authorization. If the damage is caused during the disassembly or repair, it will be out of warranty.

Do not place your device or its accessories with flammable liquids, gases or explosive materials to avoid danger.

Content

Chapter 1 Product Description	4
1.1 Product Highlights	4
1.2 Specifications	7
Chapter 2 Extended Interfaces Definition	8
Chapter 3 Introduction Of The Hardware Operation	9
3.1 ACC	9
3.1.1 ACC Connection	9
3.1.2 ACC Function	9
3.2 Using GPIO	10
3.3 Using Serial Port	11
3.3.1 RS232 Test Instruction	11
3.3.2 RS485 Test Instruction	11
3.3.3 Using CANBUS	12
Chapter 4 Introduction Of The Hardware Operation	13
4.1 Console Login	13
4.2 System Software	13
4.3 Test Software	16
Chapter 5 Standard Accessories	21
Chapter 6 Trouble Shooting	22

Chapter 1 Product Description

1.1 Product Highlights

- RK3568 (Quad-Core ARM Cortex-A55, up to 2.0GHz)
- 10.1 " Multi-point Capacitive Touch Screen, with 1280*800 Resolution
- 1000cd/m² Brightness
- Debian11 Operating System
- 2GB RAM and 16GB ROM
- Micro SD Card (TF card) Storage
- Wi-Fi and Bluetooth 5.0 (Optional)
- Built-in NFC (Optional)
- 3G/4G Network Cellular (Optional)
- GNSS (Optional)
- POE Function (Optional)
- 5.0 MP Front Camera (Optional)

1.2 Specifications

Display	
LCD	10.1" Digital IPS LCD 1280x800 resolution and 1000cd/m ² brightness
Touchscreen	Capacitive touch screen
System	
CPU	RK3568 (Quad-Core ARM Cortex-A55, up to 2.0GHz)
OS	Debian11 (kernel-5.10)
RAM	2GB DDR4
Storage	16GB eMMC
GPU	Mali-T764 • ARM G52 2EE

	<ul style="list-style-type: none"> • Support OpenGL ES 1.1/2.0/3.2, OpenCL 2.0, Vulkan 1.1 • High performance dedicated 2D processor 	
Sensor	Ambient light sensor	
	Gyroscope (Optional)	
	Accelerometer (Optional)	
	Magnetic sensor (Optional)	
Multimedia		
Audio	Integrated microphone	
	Integrated 4Ω/2W speaker	
	1 x 3.5mm stereo earphone jack comply with CTIA standard	
Video	Video Decode 1080p60 (H.265, VP9, H.264, VP8, H.263)	
	Video Encode 1080p60 (H.264/AVC, H.265/HEVC)	
Optional Functions		
GNSS	External	
WWAN	North American(A)	LTE-FDD: B2/B4/B12 LTE-TDD: B40 GSM/EDGE: B2/B4/B5
	EMEA/Korea/Thailand(E)	LTE-FDD: B1/B3/B5/B7/B8/B20 LTE-TDD: B38/B40/B41 WCDMA: B1/B5/B8 GSM/EDGE: B3/B8
	Latin America/ Australia/New Zealand (AU)	LTE-FDD: B1/B2/B3/B4/B5/B7/B8/B28 LTE-TDD: B40 WCDMA: B1/B2/B5/B8 GSM/EDGE: B2/B3/B5/B8
WLAN	IEEE 802.11 a/b/g/n/ac; 2.4GHz / 5GHz;	
	Support MCS 0-7 for HT20 and HT40	
Bluetooth	2402MHz~2480MHz	

	Integrated Bluetooth 4.2 LE + EDR class 2, with HID, A2DP, AVRCP, BIP, BPP, FTP, HFP, HSP, OPP, SPP supported
Cellular Network	3G/4G
Front Camera	500MP
NFC	Read/write Mode: ISO/IEC 14443 A&B up to 848 Kbit/s, Felica at 212&424 Kbit/s
	MIFARE 1K, 4K, NFC Forum type 1, 2, 3, 4, 5 tags.
	ISO/IEC 15693 All peer-to-peer modes
	Card Emulation Mode (from host): NFC Forum T4T (ISO/IEC 14443 A&B) at 106 Kbit/s; T3T Felica
Interface	
Serial Port	RS232x2, RS485x2, RS422x1
USB Port	Type Cx1 (OTG USB2.0), TYPE-Ax1 (USB2.0), TYPE-Ax1 (USB3.0)
Nano SIM Card Slot	x1, 1.8V/2.95V
Micro SD Card Slot	x1, 1.8V/3.3V, Supports SD V3.01 and MMC V4.51 protocols, up to 1TB.
GPIO	GPIOx4 (Each GPIO direction is configurable by software, default 4 input GPIOs, Low level Triggled)
CAN bus	x2, supporting CAN 2.0B protocol
RJ45	x1, 10/1000Mbps, and support POE supply (optional 25W supply)
ACC	x1
Power	
Power Voltage	9-36V (ISO7637-II)
Power Consumption	≤16W
Others	
Speaker	Built-in 2W, 80db
Operating Temp.	-10°C ~ 60°C (-14°F ~ 140°F)

Storage Temp.	-20°C ~ 70°C (-4°F ~ 158°F)
Operating Humidity	95% (non-condensing)
Dimension (LWD)	249x166x32mm
Weight	905g

1.3 Structure Explanation

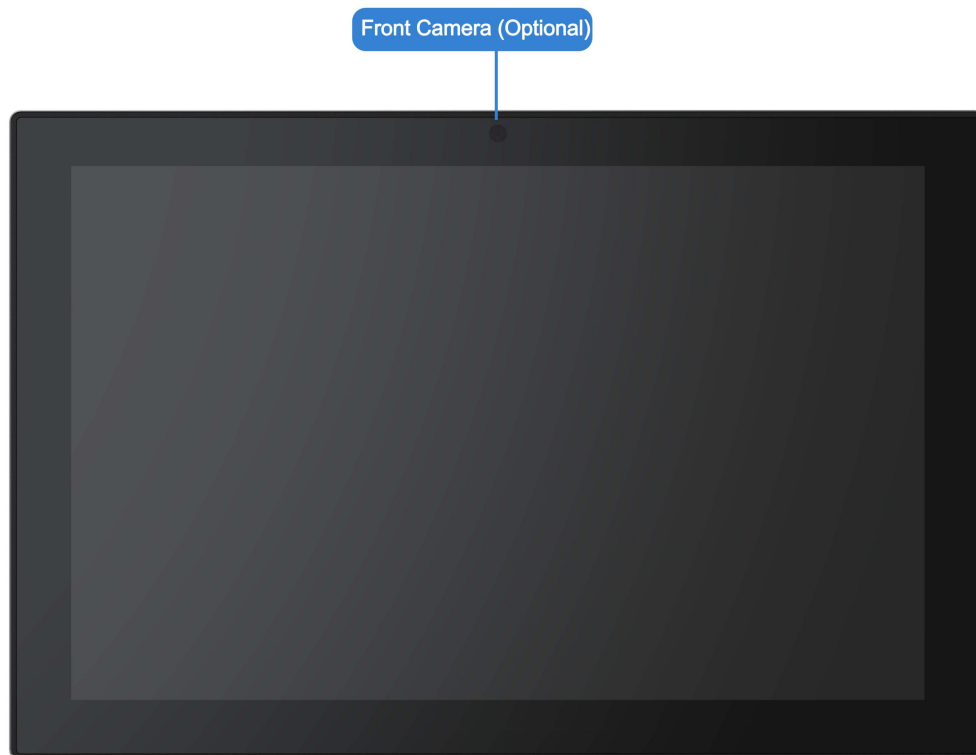

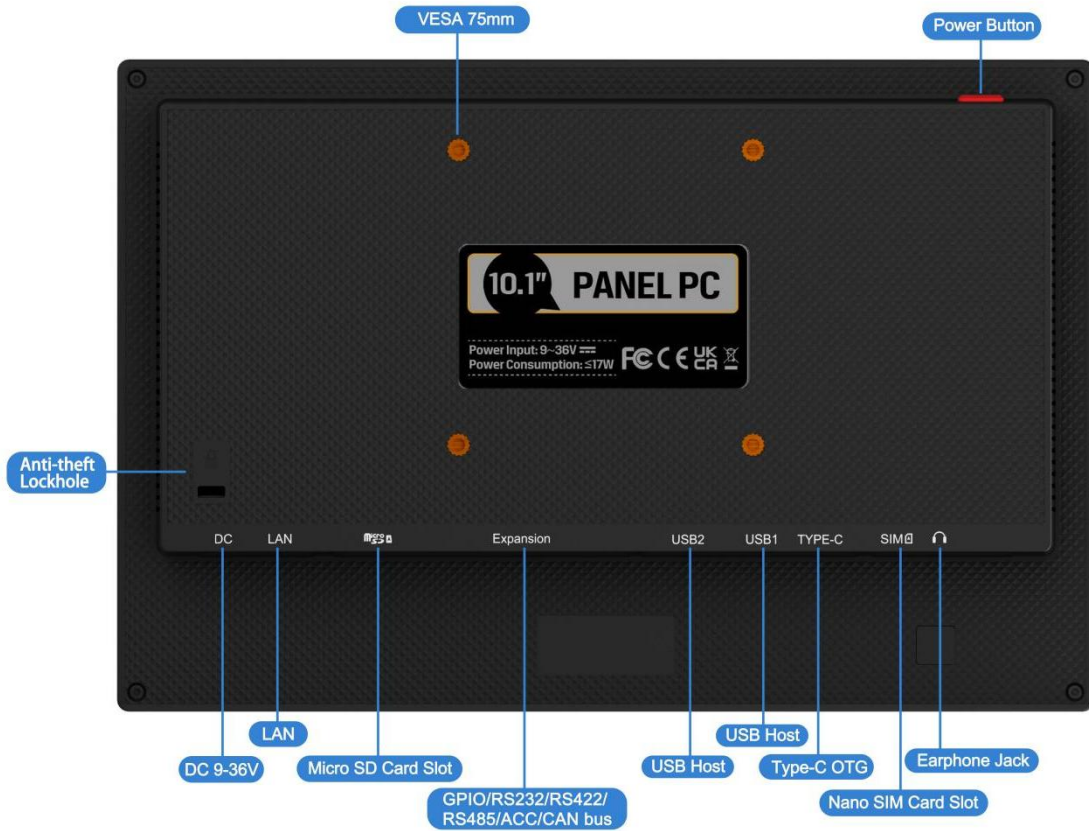

Chapter 2 Extended Interfaces Definition

The Definition of 30 Pin Socket

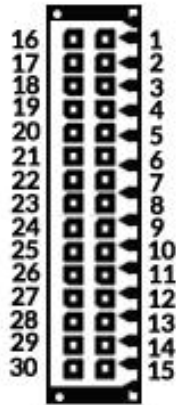
Pin	Definition				
	Pin 1	Pin2	Pin 3	Pin 4	Pin 5
	RS232_RXD4	RS232_TXD4	RS232_RXD2	RS232_TXD2	VCC_5V0
	Pin 6	Pin7	Pin 8	Pin 9	Pin 10
	GND	CAN1_L	CAN1_H	GND	CAN0_L
	Pin 11	Pin12	Pin 13	Pin 14	Pin 15
	GAND0_H	GND	GND	RS422_Y	RS422_Z

	Pin 16	Pin17	Pin 18	Pin 19	Pin 20
	IN/OUT_1	IN/OUT_2	COMMON	IN/OUT_3	IN/OUT_4
	Pin 21	Pin22	Pin 23	Pin 24	Pin 25
	ACC	GND	RS485_A1	RS485_B1	GND
	Pin 26	Pin27	Pin 28	Pin 29	Pin 30
	RS485_A2	RS485_B2	GND	RS422_A	RS422_B

Chapter 3 Introduction Of The Hardware Operation

3.1 ACC

3.1.1 ACC Connection

Please connect power port of the device to vehicle battery, and connect the ACC wire of the device to the ACC of vehicle.

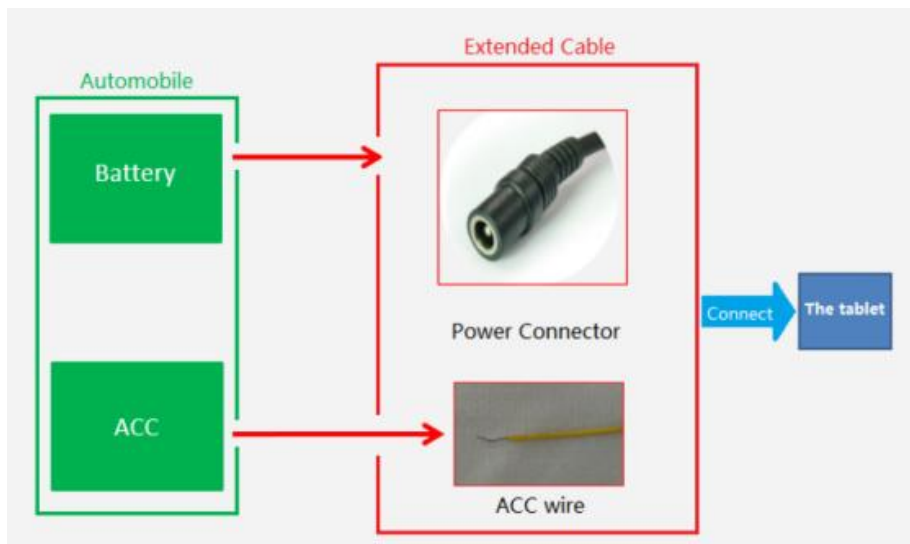

3.1.2 ACC Function

- Power on the device via ACC.

- Wake up the screen via ACC when the PC is in sleep mode.
- Turn off the screen via ACC according to the delay time set in advance.
- Power off the device via ACC according to the delay time set in advance.

Note:

- The ACC is triggered by the electric level.
- The function of "Power on the device by ACC" can't be modified from the system.
- It will take about 10 seconds to completely shut down the system after ACC is started. Please do not try to use any boot-triggered action during this process.

3.2 Using GPIO

GPIO Typical Connection

The following figure is a typical connection method of GPIO. In order to ensure communicate normally, please connect the GPIO interface of Tablet as shown in the following figure.

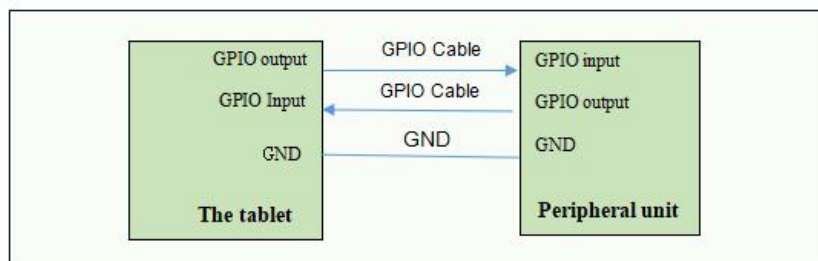

Note: When GPIO outputs an external inductive load or reactor, diodes need to be connected in parallel at both ends. Diode current rating is suggested 1A, such as type 1N4007.

Generation of the counter electromotive force that exceeds the output rating is prevented by discharging through the clamp diode.

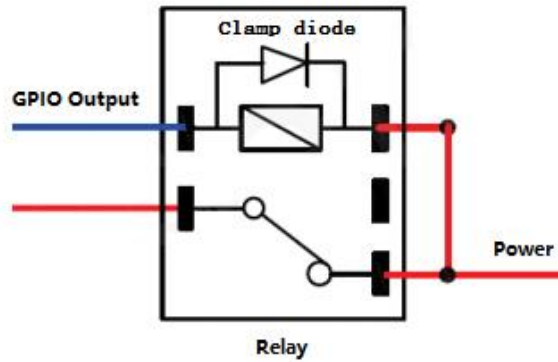

Typical relay connection

Users can also connect the common pin provided with the extension interface.

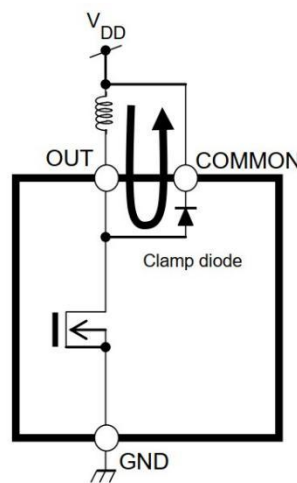

3.3 Using Serial Port

3.3.1 RS232 Test Instruction:

Connect Pin2 and Pin3 of the COM1 (or COM2) interface together through a wire, then the receiving window will display the Received data of the port. The received data is consistent with the sent data, indicating that the serial port can communicate normally.

3.3.2 RS485 Test Instruction:

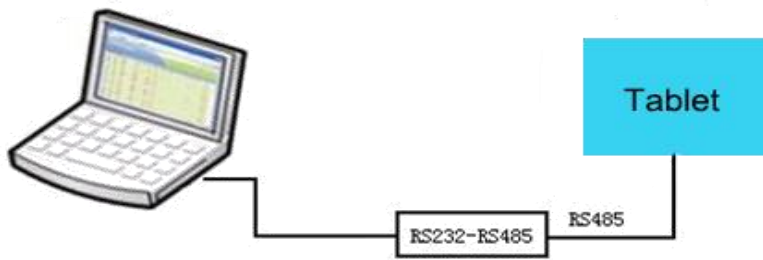

Select the "Auto" checkbox in the testing software interface and click the "SEND" button. Connect the positive terminal (RS485+/RS485_A) of the tail wire's RS485 line to the positive terminal of the RS485 line of the other device, and connect the negative terminal (RS485-/RS485_B) to the negative terminal. The RS485 receive window in the testing software interface will display the received RS485 data. If the received data matches the data sent by other RS485 devices, it indicates that RS485 communication is functioning properly.

If the tablet is located far away from the connected device or the baud rate is above 115200, it is recommended to connect a 120-ohm resistor between the positive and negative terminals of the RS485 interface if communication issues occur.

3.3.3 Using CANBUS

The CANBUS bus connection method is shown in the following figure:

When using high-frequency signal transmission on the CAN bus, in order to ensure the transmission quality of the signal, it is recommended to connect a 120Ω terminal matching resistor to each end of the CAN bus.

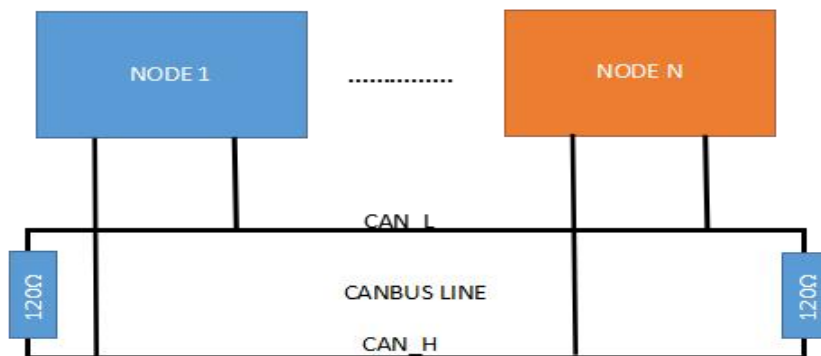

Recommended CANBUS bus connection diagram

Chapter4 Test Description

4.1 Console Login

1. The product is connected to the PC COM1.
2. Setting up the PC serial port parameters as shown as shown below.

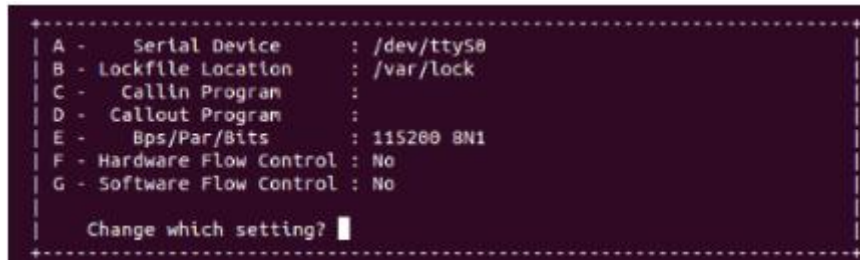

4.2 System Software

1. Soft Keyboard xvkbd

Applications→Accessories→xvkbd. Virtual Keyboard as shown below.

Function buttons area are shown in the left of keyboard including hidden, set, move, zoom in, zoom out.

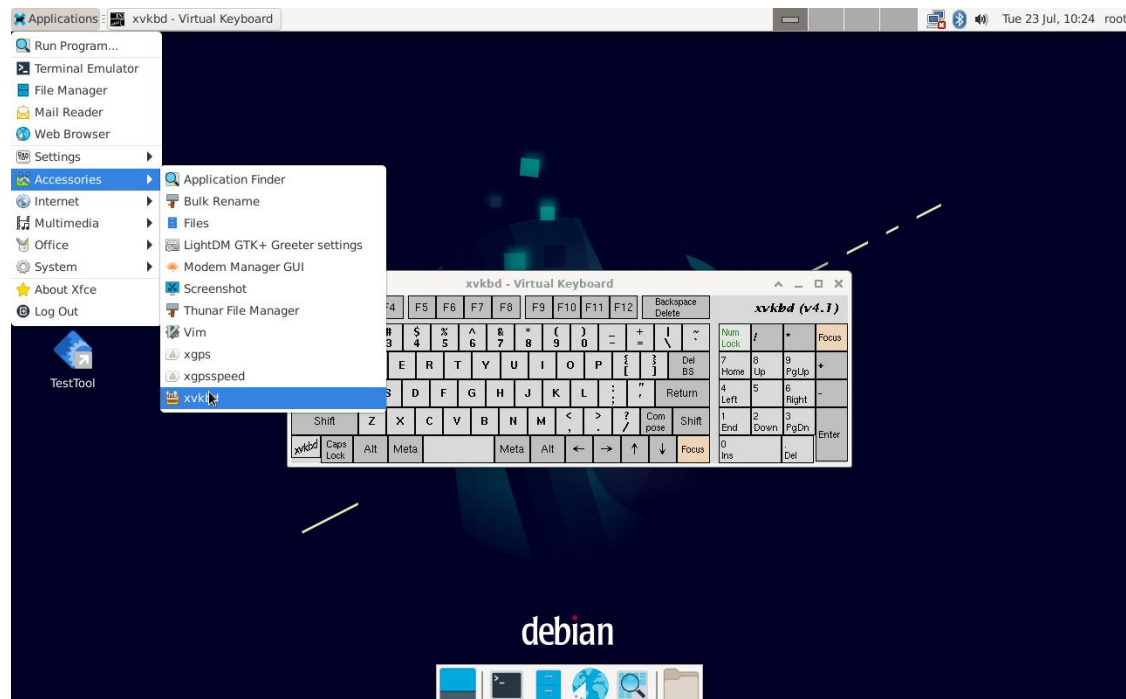

2. Browser Chromium

Applications→Internet→Chromium Browser. Browser as shown below.

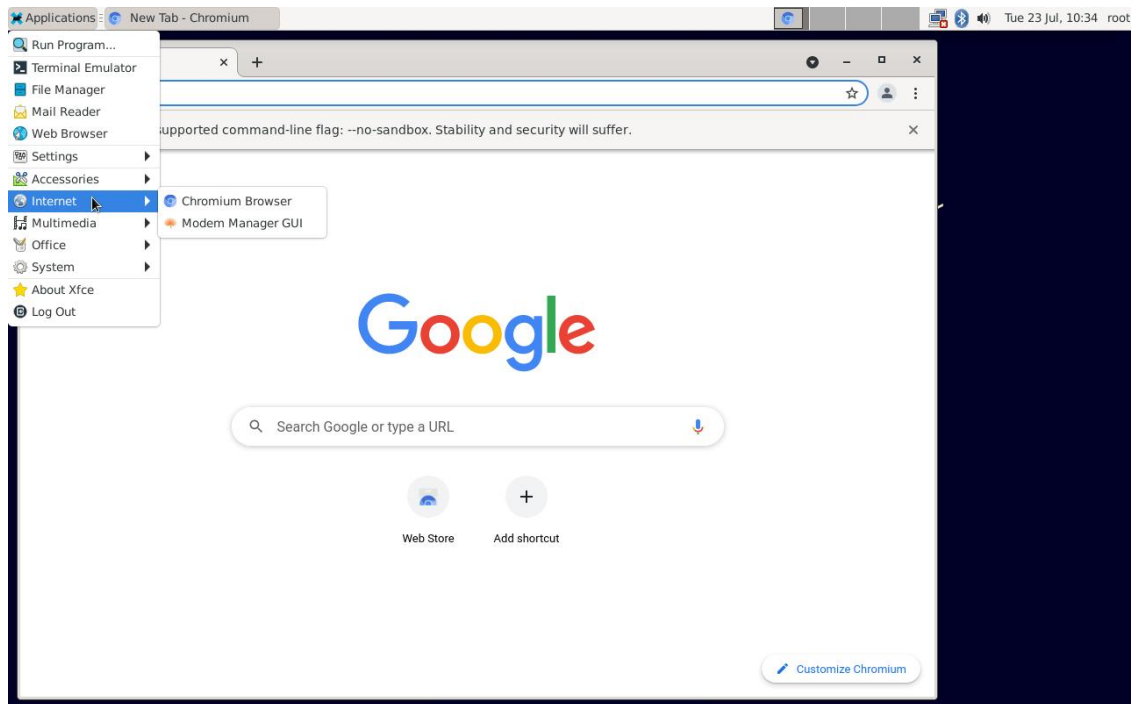

3. Wi-Fi Connection

Click the Network icon in the top right corner of the tablet desktop. Wi-Fi Networks as shown below.

Open the software, device will automatically scan WIFI devices within the range. After selecting the WIFI device to be connected, input the corresponding WIFI password for connection when the keyboard pop up. After successful connection, the WIFI signal strength is displayed in the top right corner.

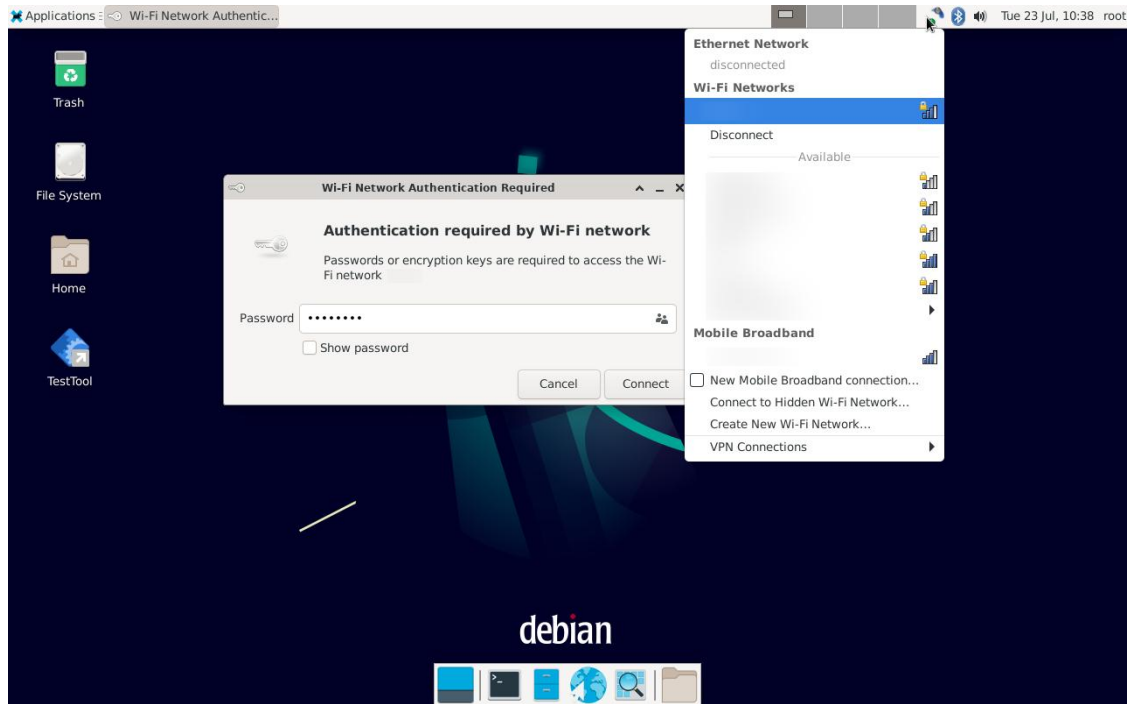

4. 4G Signal

Insert the SIM card, device will automatically connect to the 4G network. Open the browser test whether you can access the Internet. After successful connection, the 4G connection is displayed in the top right corner.

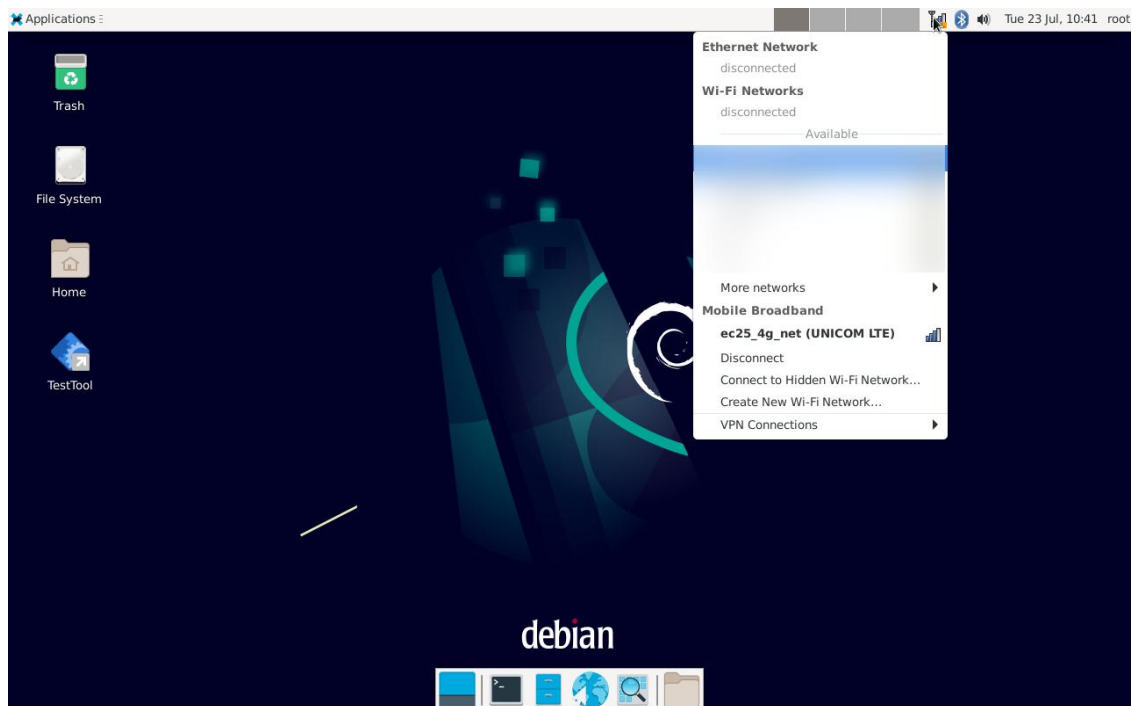

5. Bluetooth

Applications→Settings→Bluetooth Manager. Bluetooth Manager as shown below

Click search first to scan the surrounding Bluetooth devices before pairing, if succeed, files can be received and sent.

If you want to close Bluetooth, you can also click the Bluetooth icon in the top right corner of the tablet desktop.

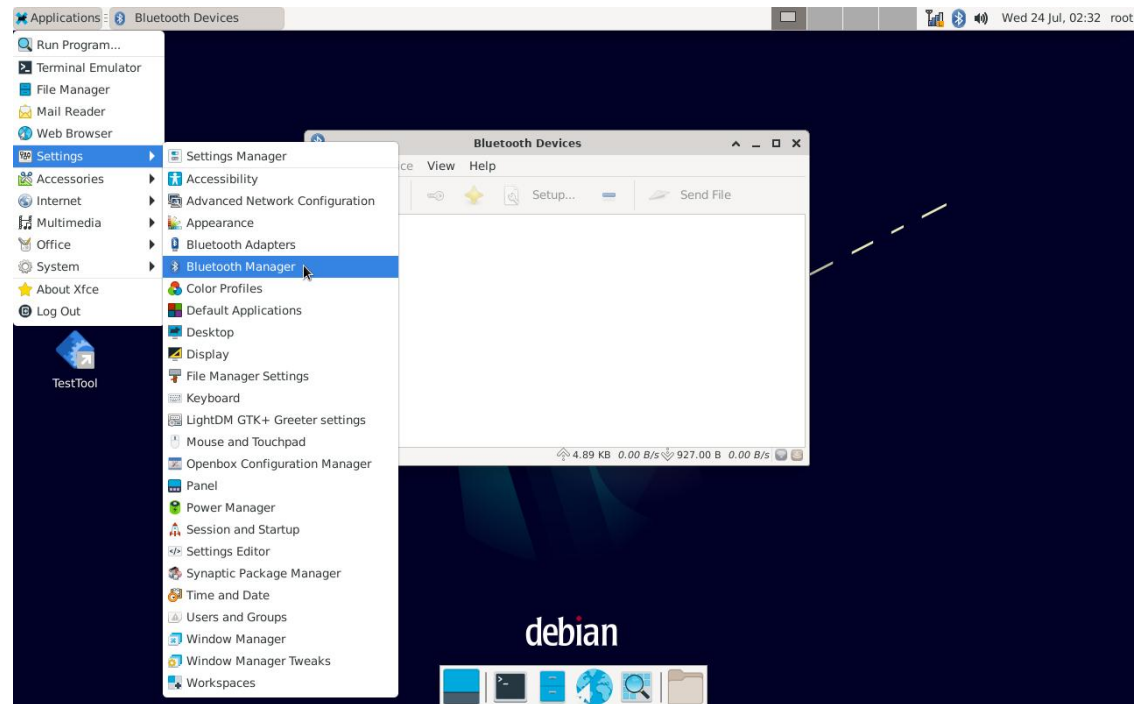

4.3 Test Software

The “TestTool” is in the tablet desktop. Click to open it.

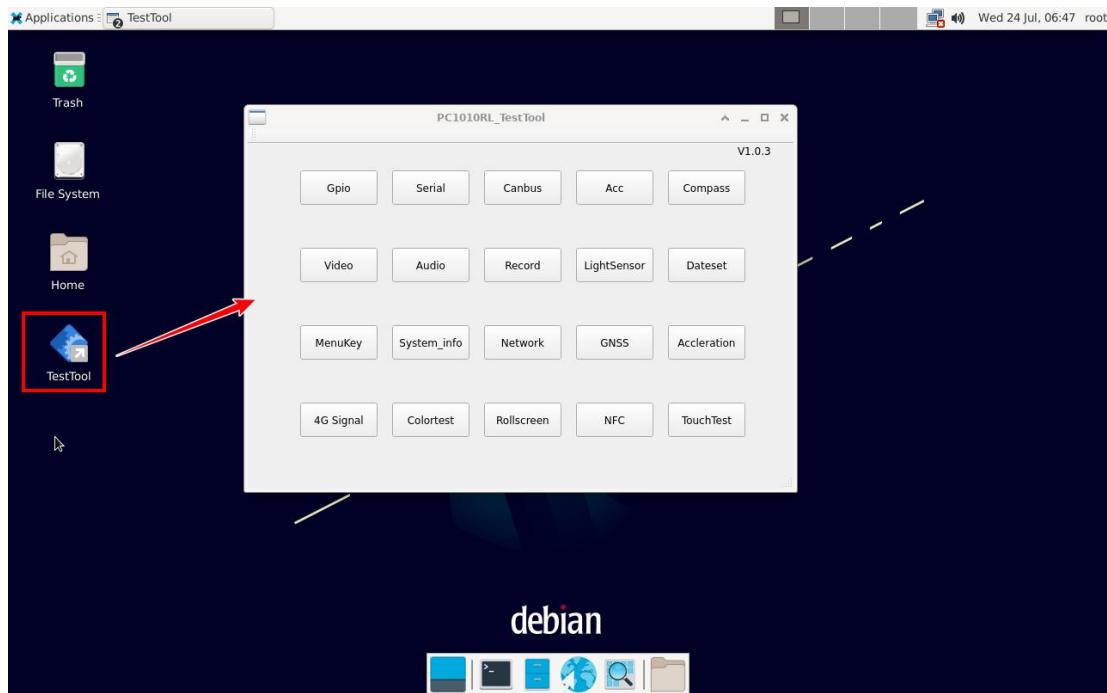

1. ACC Test

TestTool→ACC. The ACC is triggered by the electric level. ACC function as shown below.

- ① Check to enable ACC screen off function.
- ② Check to enable ACC shutdown function.
- ③ Check to allow auto start ACC after reboot.
- ④ Set ACC screen off delay time.
- ⑤ Set ACC shutdown delay time.

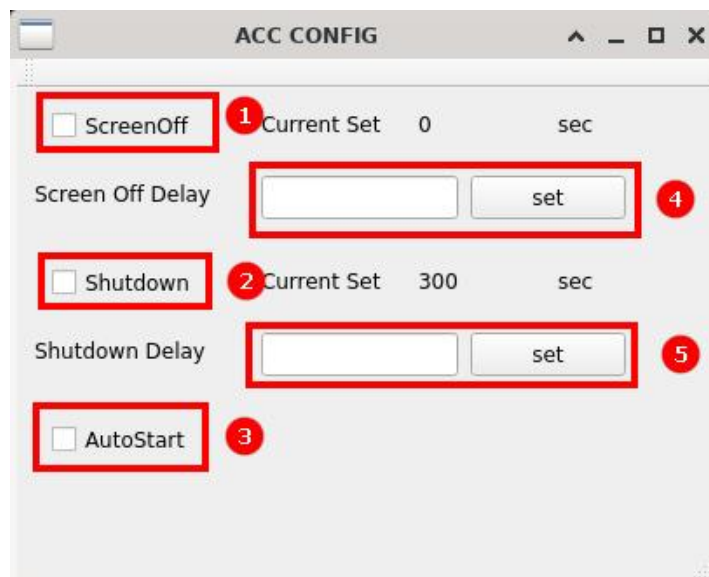

2. Vedio Player

TestTool→Vedio. The “Vedio” will use hardware rendering to play videos, as shown below.

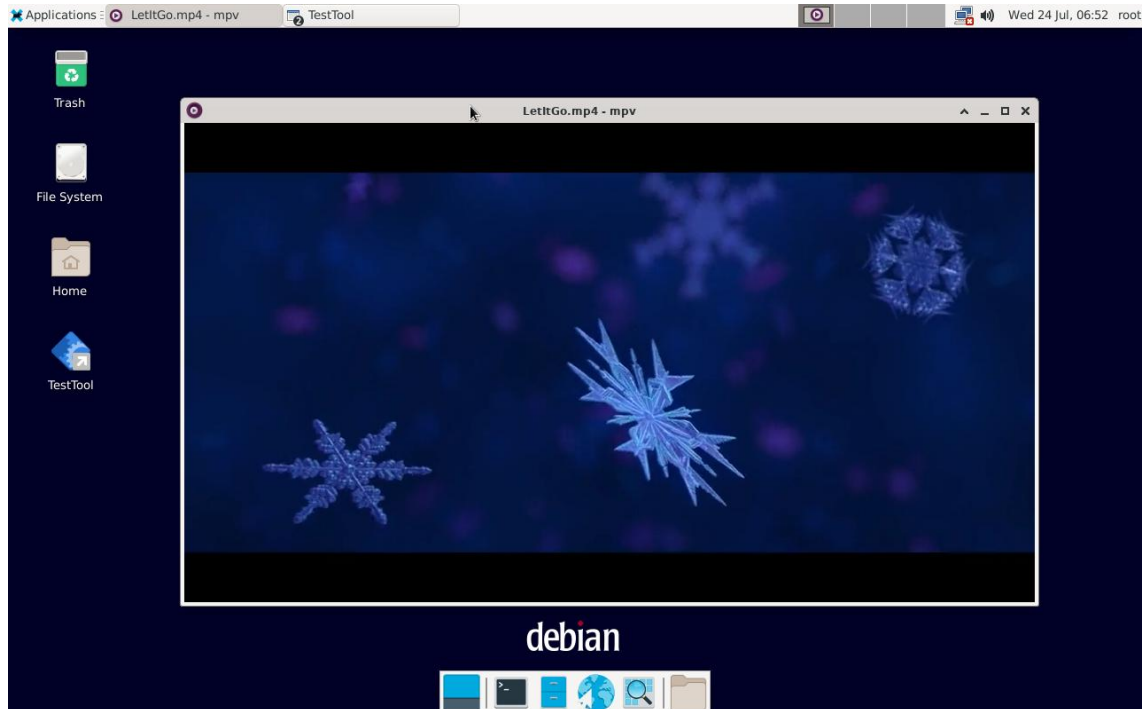

3. Audio Player

TestTool→Audio. Click “Play” button to play test audio.

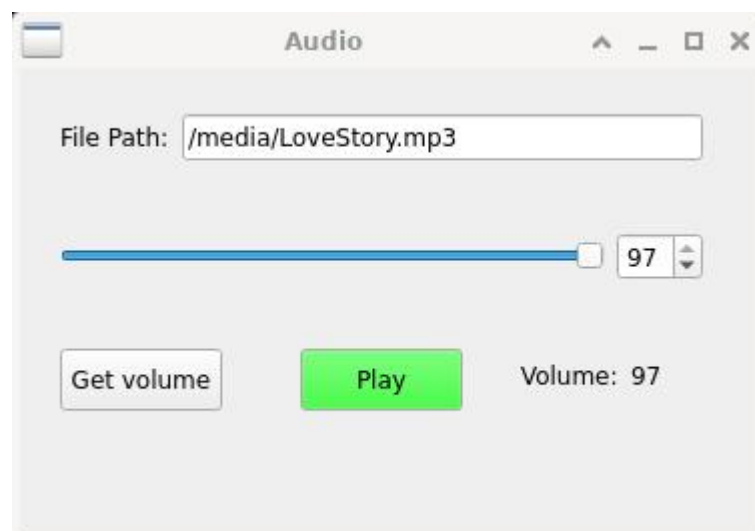

4. Voice Recorder

TestTool→Record. Click the “Record” button to start recording. After the recording

ends, click “Stop” button to stop recording. Then click the “Play” button to play the recorded file.



5. Date Set

TestTool→Dateset. After clicking the “save” button, the system clock will be written into the hardware clock.

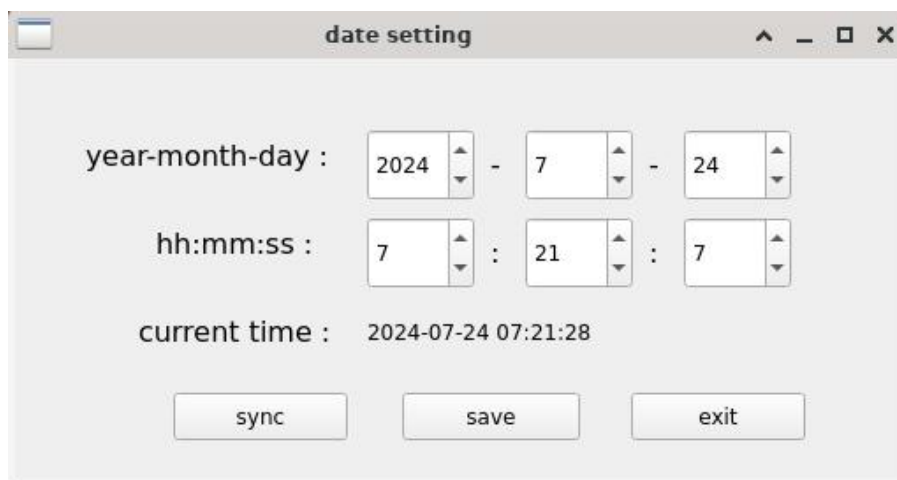

6. CAN Bus

TestTool→Canbus. click the “open” button to open the CAN device. After select the desired baud rate and frame format, click the “send” button. The device will automatically send CAN data.

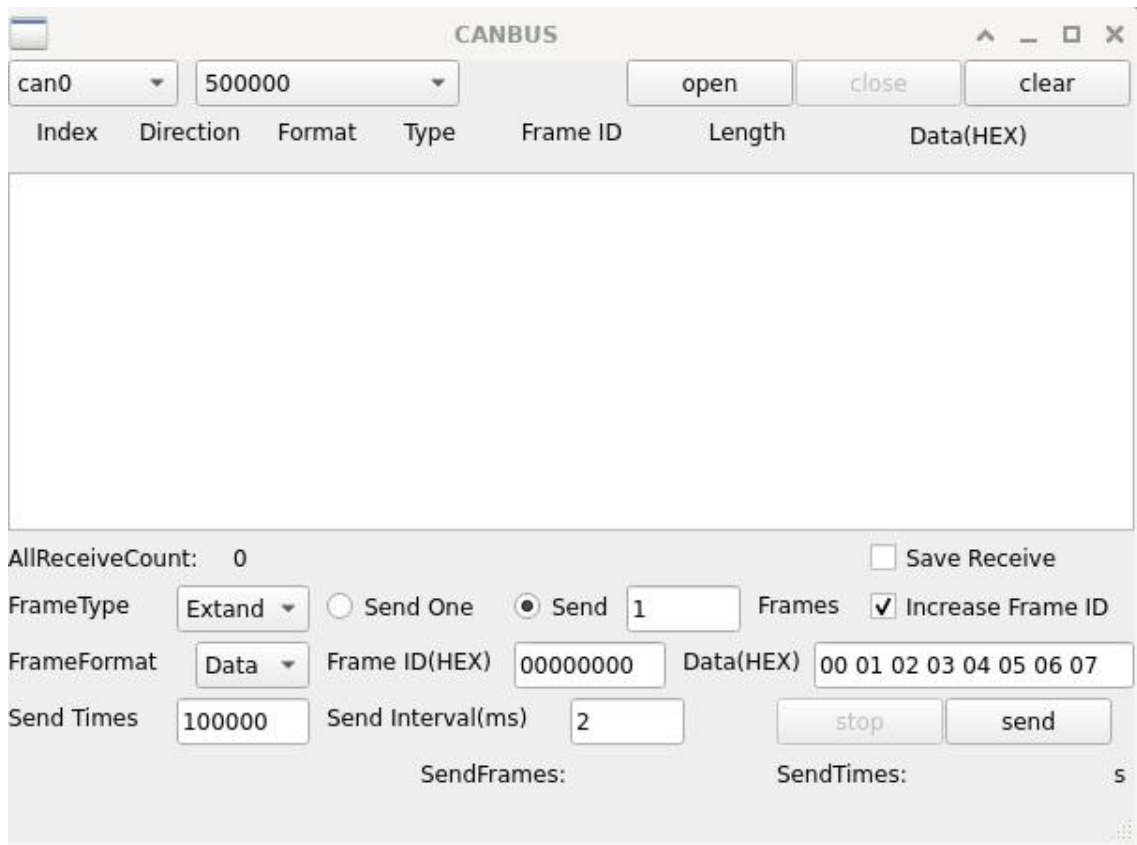

7. GPIO

TestTool→GPIO. The “GPIO” function as shown below.

- ① Set GPIO as input.
- ② Display GPIO input values.
- ③ Set GPIO output 0 on the left and GPIO output 1 on the right.

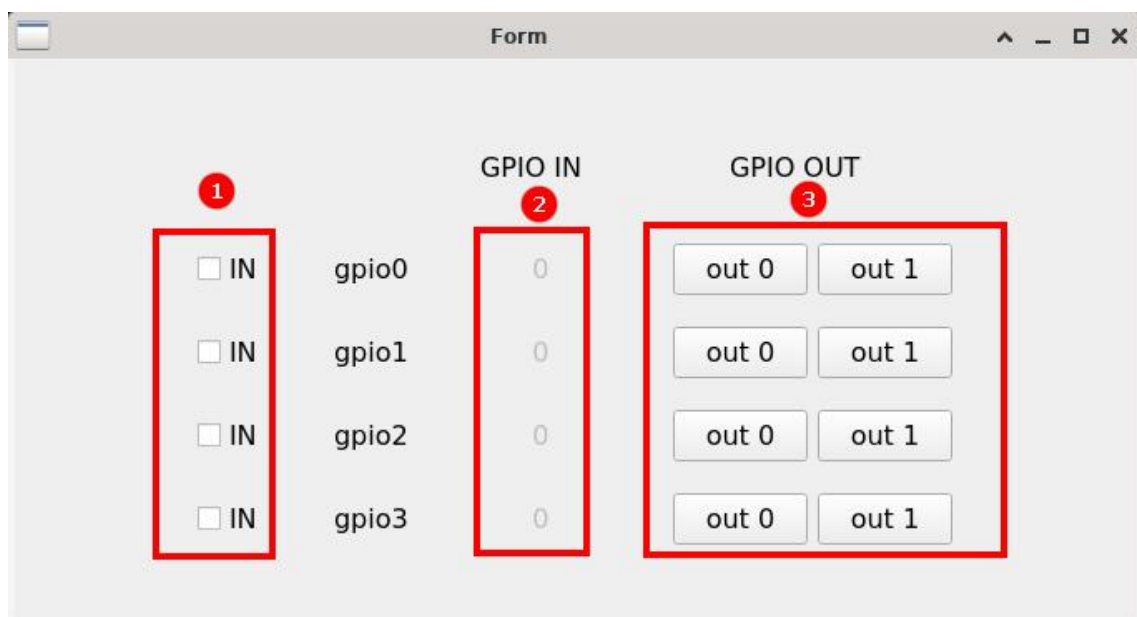

8. Serial

TestTool→Serial. After clicking the open button, text will be automatically sent to the corresponding serial port.

In the upper left corner of the software window, select "MODE" and choose RS232, RS485, or RS422.

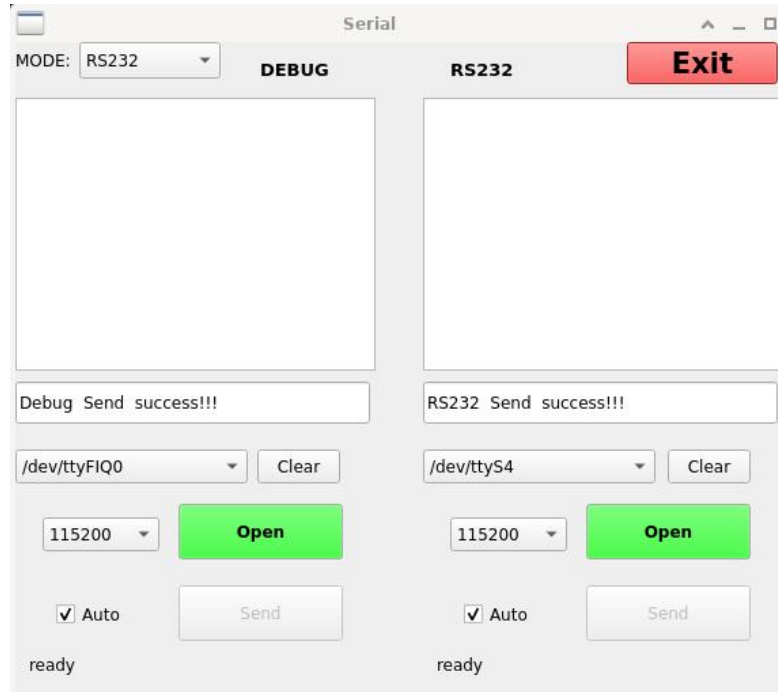

Chapter 5 Standard Accessories



12V 2A DC Adapter



USB-A To USB-C Cable



Matching Socket



User Manual Card

- | | |
|-------------------------|------|
| 1) 12V 2A DC Adapter | 1pcs |
| 2) USB-A To USB-C Cable | 1pcs |
| 3) Matching Socket | 1pcs |
| 4) User Manual Card | 1pcs |

Chapter 6 Trouble Shooting

Problems	Problem Description	Solutions
Power Problems	Unable to boot	Please check if the connection is correct.
		Bad contact: please check the power socket and plug.
Display Problems	No display	Please power off and restart the system.
	When clicking a function, the execution time is too long to activate.	
	The screen switching process is delayed and stagnant, causing the screen to fail to switch smoothly	
	Blurred display	Check whether there is dust on the surface of the display. If yes, please wipe the dust on the surface with a soft cloth that does not drop cotton chips.